

**Middletown Senior Center**  
*Furniture Options*

**Cafeteria Furniture:**

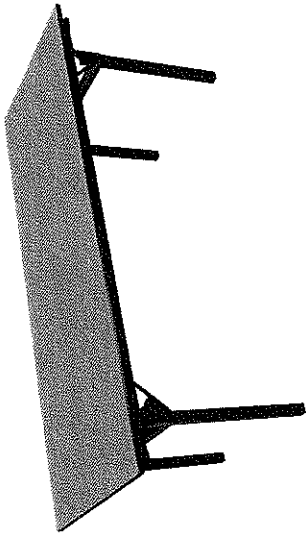

T01 Option 1  
 Shelby Williams Folding Table

\$618 Qty. 15

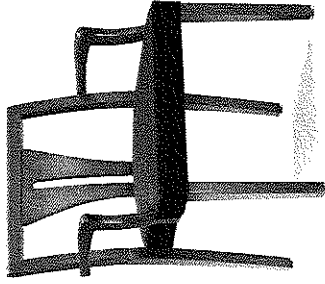

CH01 Option 1  
 Trinity Furniture: Luci Gucci  
 Stacks 6 high on cart  
 Cart holds 6 chairs \$203

\$303 Qty. 123 \$37,269

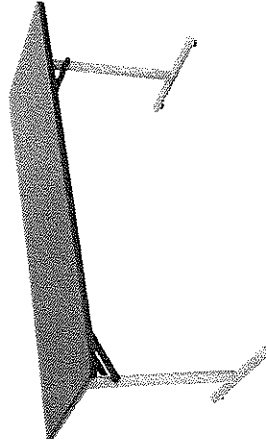
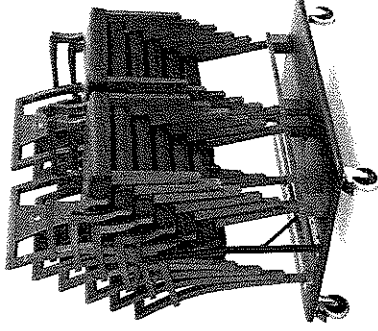

T01 Option 2  
 Falcon Folding Table

\$661 Qty. 15

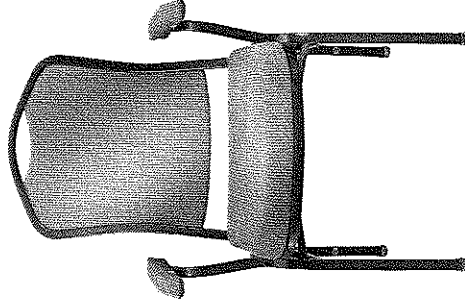

CH01 Option 2  
 Shelby Williams Metal banquet Chair  
 Stacks 12 high on cart  
 Cart holds 12 chairs \$441

\$268 Qty. 123 \$32,964

**Middletown Senior Center**  
*Furniture Options*  
**Classroom Furniture:**

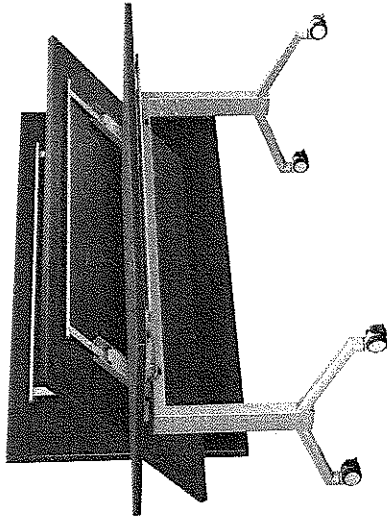

**T02 Option 1 \$489.00**  
*Right Angle Folding Table*  
*Suburban Office Furniture*

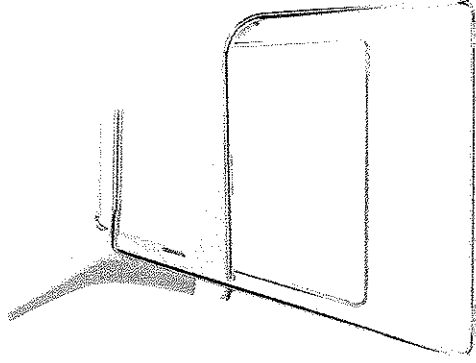

**CH07 Option 1 \$130**  
*All Seating Stacking Chair*  
*Suburban Office Furniture*

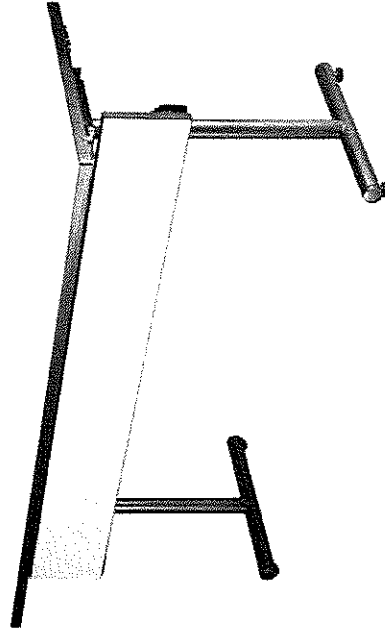

**T02 Option 2 \$542.00**  
*Falcon T leg Folding Table*

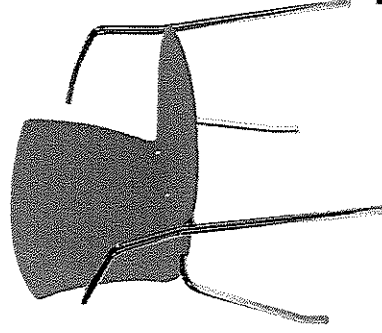

**CH07 Option 1 \$198**  
*Falcon Stacking Chair*

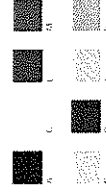

**Middletown Senior Center**  
Furniture Options

**Art & Crafts Furniture:**

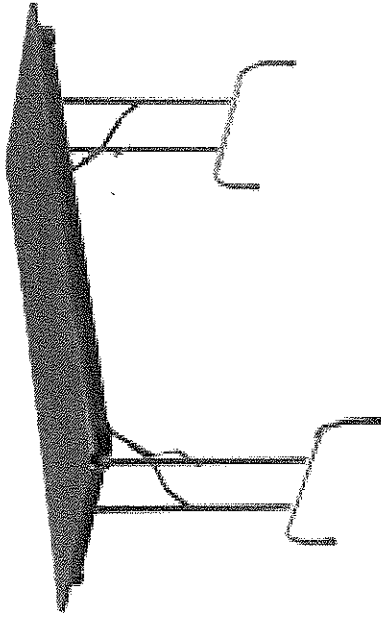

T04 Option 2 \$206  
Virco: Folding Table

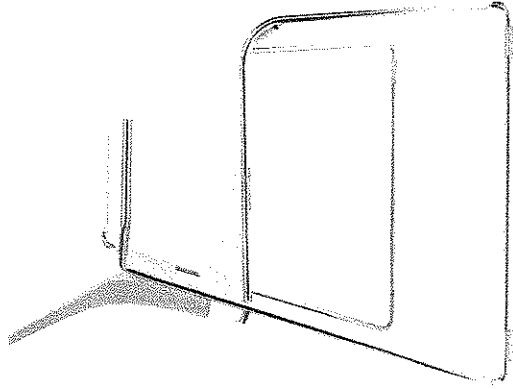

CH07 Option 1 \$130  
All Seating Stacking Chair  
Suburban Office Furniture

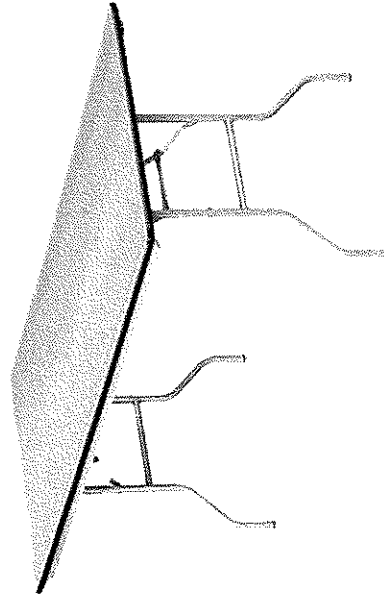

T04 Option 2 \$216  
Shelby Williams: Folding Table

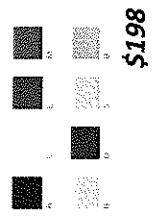
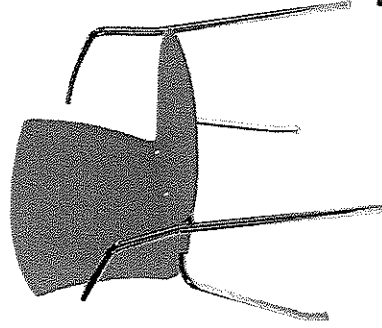

CH07 Option 1 \$198  
Falcon Stacking Chair

**Middletown Senior Center**  
*Furniture Options*

**Library Furniture**

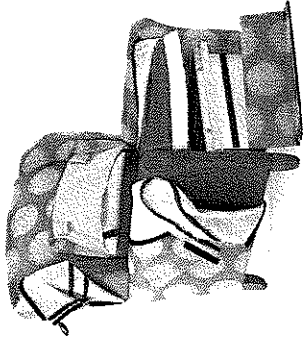
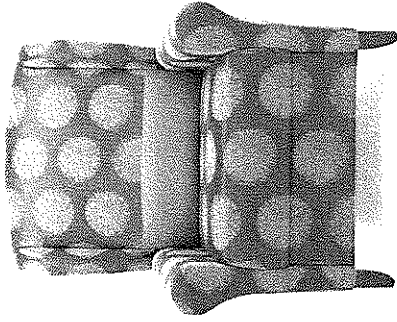

**CH06 Option 1 \$1,075 Qty. 4 \$4,300**

Trinity Furniture: Facelift Collection  
*Velcro attached upholstery, antimicrobial moisture barrier, antimicrobial wood finish, and onsite replaceable components.*

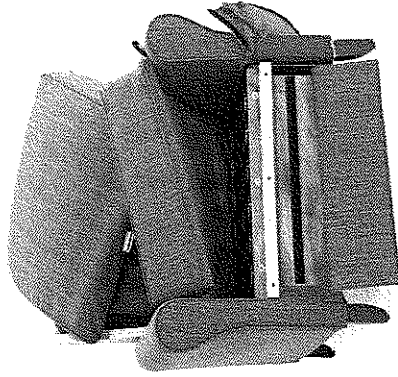
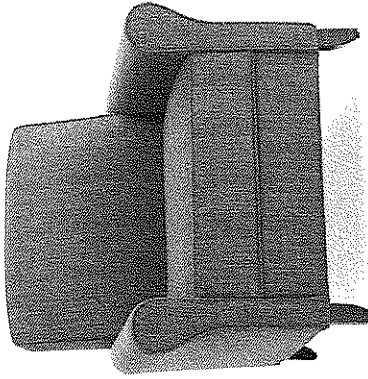

**CH06 Option 2 \$1,263 Qty. 4 \$5,052**

Trinity Furniture: Facelift Collection  
*Velcro attached upholstery, antimicrobial moisture barrier, antimicrobial wood finish, and onsite replaceable components.*

**Middletown Senior Center  
Furniture Options**

**Socialization Furniture**

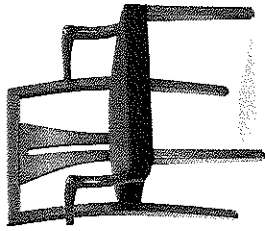

CH01 Option 1 \$303  
Trinity Furniture: Luci Gucci  
\* Solid Maple frame with antimicrobial finish

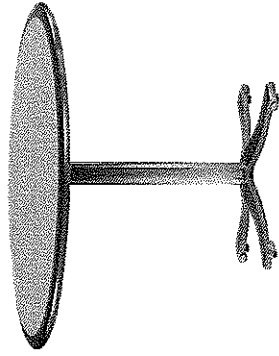

T03 \$453.12 Qty. 4 \$1,812.48  
Falcon 48" Round table  
Cast Iron base, Bronze finish

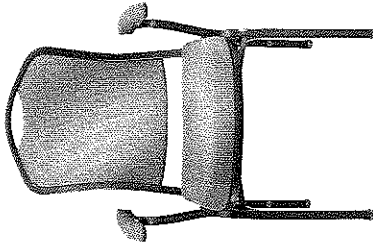

CH01 Option 2 \$268  
Shelby Williams Metal banquet Chair

**Middletown Senior Center**  
*Furniture Options*

**Lobby Furniture**

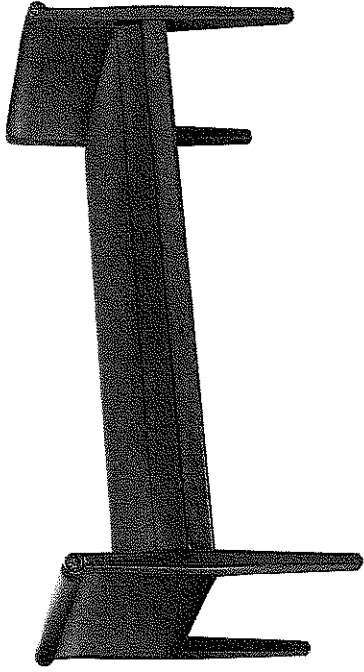

**B01** **\$634.30**  
Trinity Furniture: Classic Bench w/sides

**Middletown Senior Center**  
*Furniture Options*

**Billards Room Furniture**

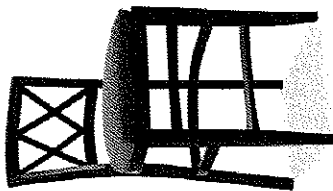

CH02  
Shelby Williams:4311-2  
\$610.23

Room	Tag	Item	Qty	Unit Price	Extended Price
Cafeteria	T-01	Multipurpose Folding Table 30 x 72	7	\$597.12	\$4,179.84
	T-01.2	Multipurpose Folding Table 30 x 96	8	\$618.24	\$4,945.92
	TC-01	Folding Table Cart	3	\$347.52	\$1,042.56
	***	Freight/Installation for Tables and Carts	1	\$545.00	\$545.00
	CH-01	Wood Stacking Chair	123	\$303.30	\$37,305.90
Arts & Crafts	CC-01	Stacking Chair Cart	8	\$189.90	\$1,519.20
	T-04	24" x 60" Folding Table	8	\$194.56	\$1,556.48
	***	Freight/Installation for Tables	1	\$174.00	\$174.00
	CH-07	Plastic Stacking Chairs	16	\$152.49	\$2,439.84
	Subtotal				\$49,538.42
Classroom	ST-01	Barstool with upholstered seat	4	\$571.52	\$2,286.08
	***	Freight/Installation for Stools	1	\$154.85	\$154.85
	T-02	Flip Top Table 24" x 60"	8	\$542.88	\$4,343.04
	CH-07	Plastic Stacking Chairs	16	\$152.49	\$2,439.84
	Subtotal				\$6,782.88
Library	CH-06	High Back Lounge Chair	4	\$1,055.70	\$4,222.80
	CH-01	Wood Stacking Chair	4	\$303.30	\$37,305.90
	Subtotal				\$41,528.70
Socialization	CH-01	Wood Stacking Chair	24	\$303.30	\$7,279.20
	T-03	Round Card Table	4	\$453.12	\$1,812.48
	Subtotal				\$9,091.68
Lobby	B-01	Upholstered Bench with sides	2	\$564.30	\$1,128.60
	***	Freight/Installation for Benches	1	\$140.00	\$140.00
Miscellaneous	***	Freight for Wood Stacking Chairs and Carts	1	\$2,247.19	\$2,247.19
	***	Receiving/Installation for Wood Stacking chairs & Lounge Chairs	1	\$1,000.00	\$1,000.00
	****	5% contingency	1	\$5,903.00	\$5,903.00
Subtotal				\$9,150.19	
Estimated Total Budget					\$123,971.72